

*European multilateral  
Cooperation  
- a Swedish view*

*Washington, D.C., October 9, 2003*

*Stephan Källmén  
stephan.kallmen@foreign.ministry.se*



*Letter of Intent/Framework Agreement*

*France, Germany, Italy\*, Spain, Sweden,  
and United Kingdom.*

*Now ratified by Italy, enters into force October 2nd, 2003*



*Executive Committee (ExCo)*

*(presently chaired by Spain)*

*Six Sub-Committees*

*(one chairman per country)*

## *SC 1 - Security of Supply*

- \* Implementing Arrangement finalised*
- \* Code of Practice on the Defence Industry Restructuring*
- \* Code of Conduct on Priorities System*
- \* Future work (Control of Foreign Investment)*

## *SC 2 - Export Procedures*

*\*Implementing Arrangement finalised*

*\* Future work (Free Circulation and  
Technology Transfer, Information on Export  
Control Organisations)*

## *SC 3 - Security of Information*

*\* Implementation per October 2002*

*\* Procedural Guidelines finalised*

# *SC 4 Research & Technology*

*Group of Research Directors (GRD)*

*\* Implementing Arrangement finalised and signed*

## *SC 5 - Treatment of Technical Information*

- \* Implementing Arrangement finalised*
- \* Future work (Patent Security, Levy and Deliverable Information)*



*SC 6 - Harmonisation of Military  
Requirements*

*(HMR Support Team)*

- \* Implementing Arrangement finalised and signed*
- \* Future work (contact ECAP Projects Groups and NATO PCC)*

## *Additional (informal) Working Groups*

*\* Export Promotion*

*\* Reciprocal Offset Waivers*







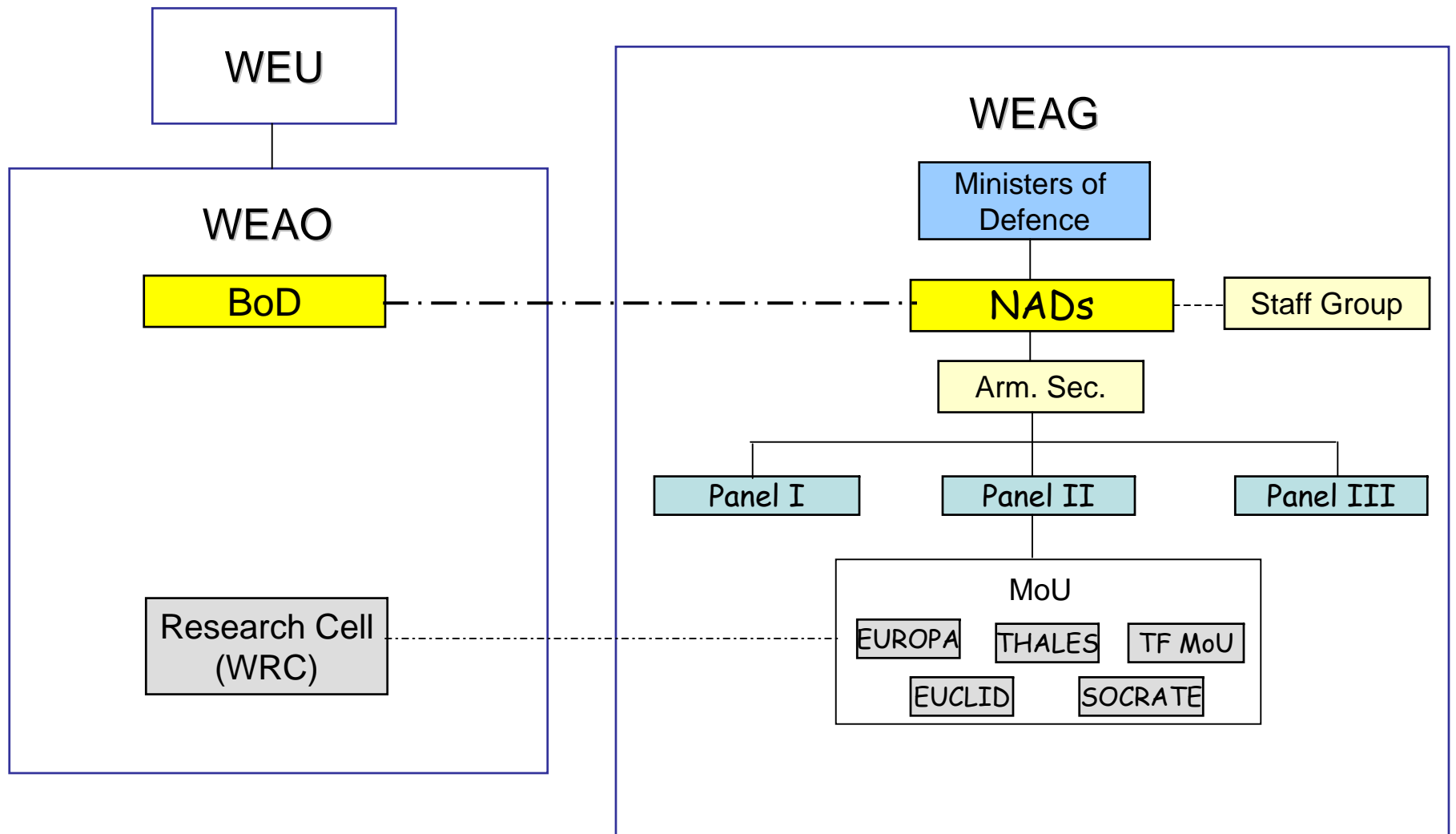

















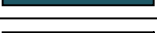



















*Cont.*

- \* *Measurements of Benefits (UK)*
- \* *EU Intergovernmental Agency*  
*(LoI Common approach)*

# WEAG/WEAO



# Membership

	EU	OCCAR	LOI	WEAG	
Ireland					
Belgium					
Greece					
Portugal					
Denmark					
Luxembourg					
Netherlands					
Finland					
Austria					
Spain					
<b>Sweden</b>					
UK					
France					
Germany					
Italy					
Turkey					
Poland					
Hungary					
Czech Republic					
Norway					

# OCCAR

(Organisation Conjointe de Cooperation en Matière d'Armement)

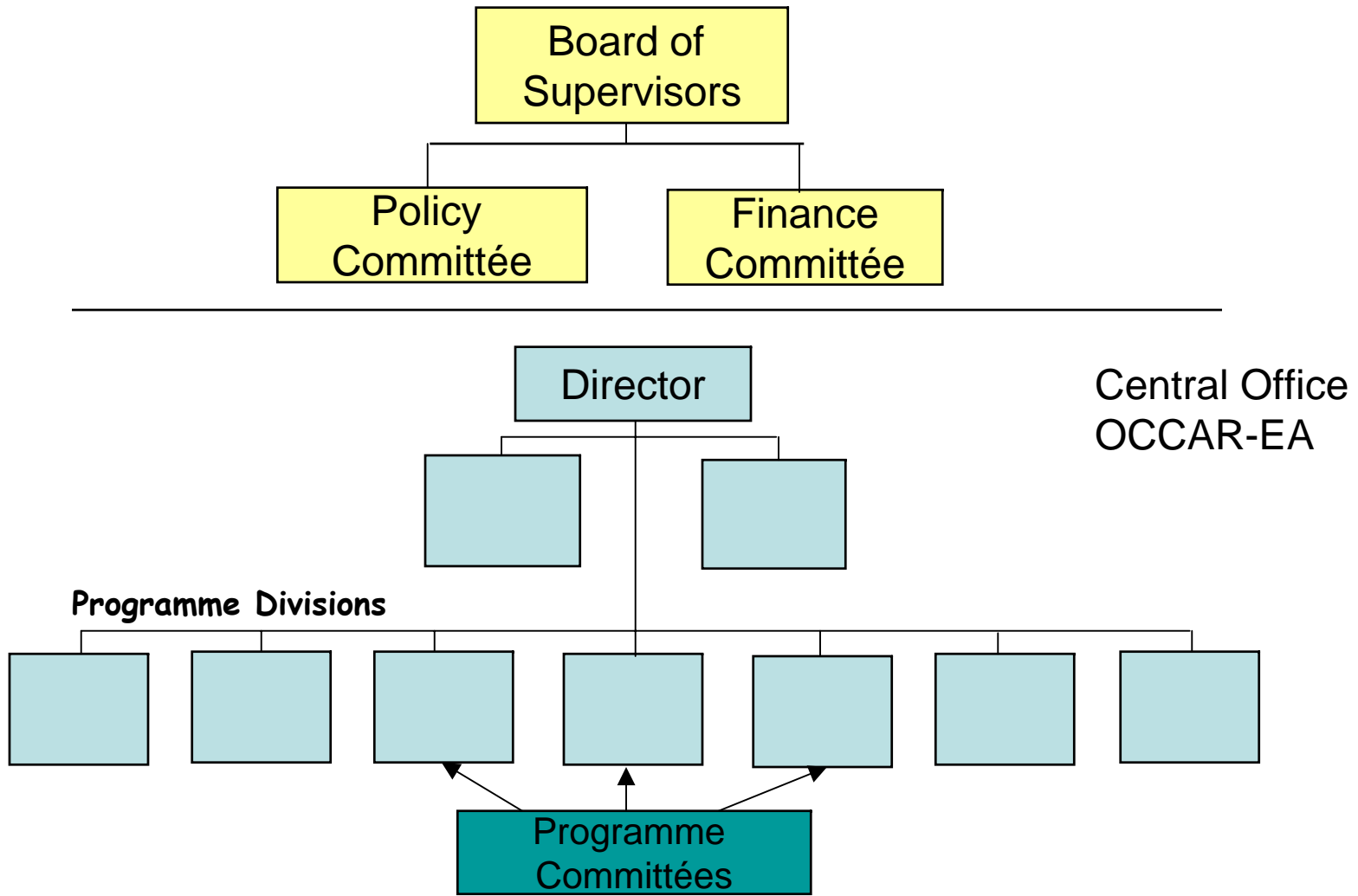

# OCCAR

## The Five Principles

- Cost effectiveness
- Harmonisation (requirements, technology)
- Competitive industrial base
- Renunciation of "Juste Retour"
- Open to other countries

*Thank you!*

*Questions?*

